

VAPEUR LAMPS
Designed by Inga Sempé
2009

IMPORTANT!
En cas de problème lors de l'installation, contactez un électricien. Coupez le courant avant de commencer l'installation. Moustache vous conseille d'utiliser une ampoule à économie d'énergie.

IMPORTANT!
If you have any problems regarding the electrical installation, contact an electrician. Always shut off power to the circuit before starting installation work. Moustache advise you to use an energy saver bulb.

Moustache
www.moustache.fr

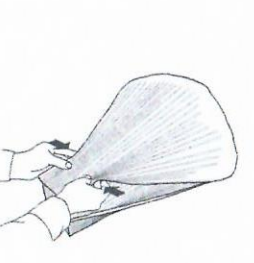
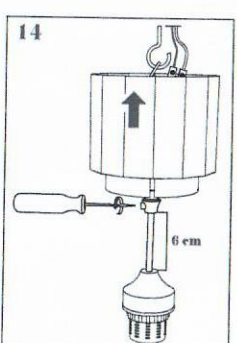
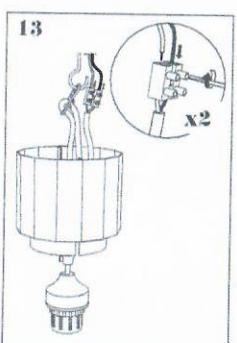
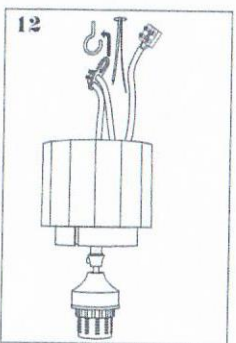
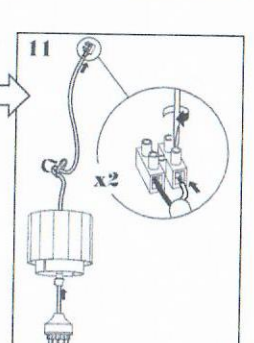
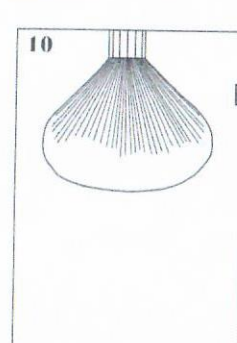
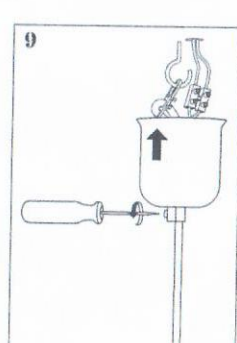
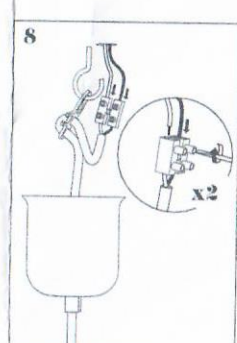
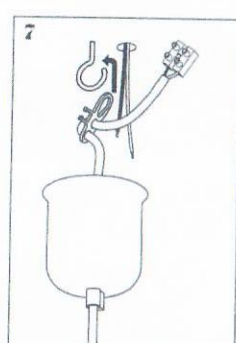
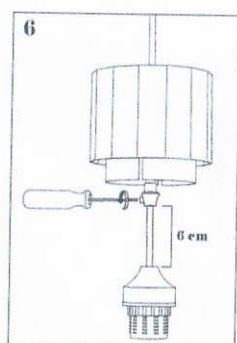
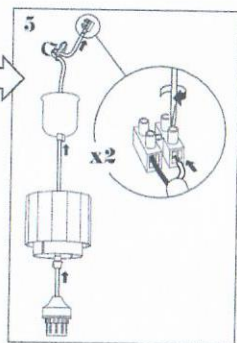
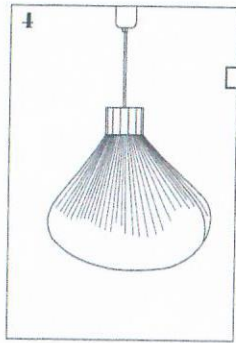
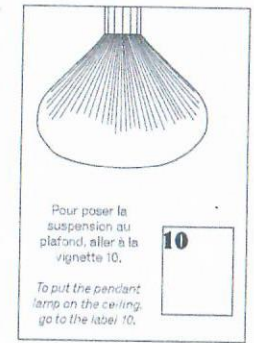
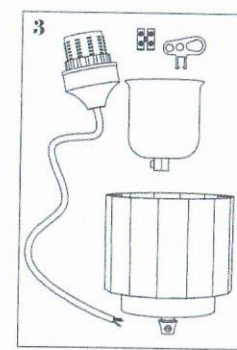
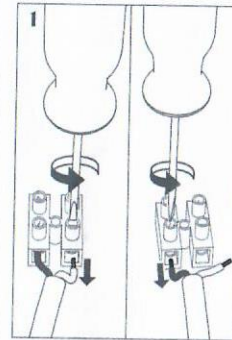
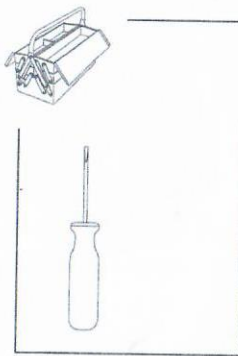

Former le volume de l'abat-jour en passant la main à l'intérieur.
Form the shape of the lampshade by moving your hand inside.

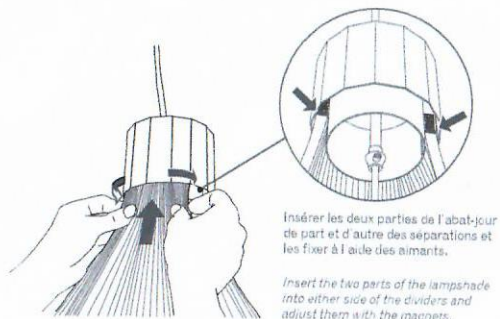

Insérer les deux parties de l'abat-jour de part et d'autre des séparations et les fixer à l'aide des aimants.

Insert the two parts of the lampshade into either side of the dividers and adjust them with the magnets.

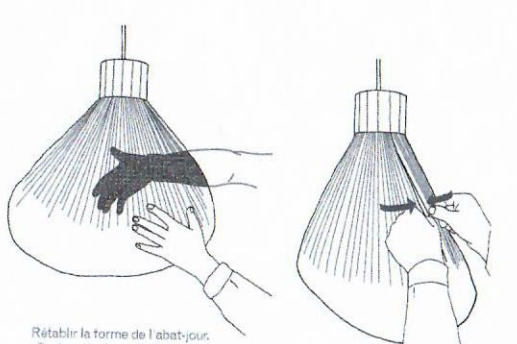
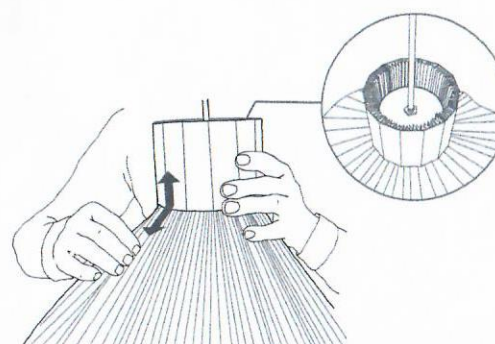
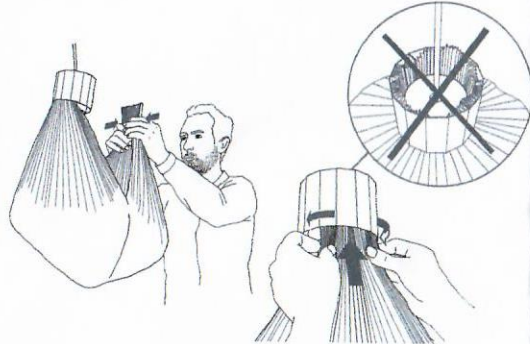

Rétablir la forme de l'abat-jour.
Restore the lampshade shape.